

WE NOT ONLY RECOMMEND THAT CHILDREN ARE SUPERVISED AT ALL TIMES BUT ALSO ADVISE THAT SAFER SURFACING BE USED FOR ALL OUR EQUIPMENT

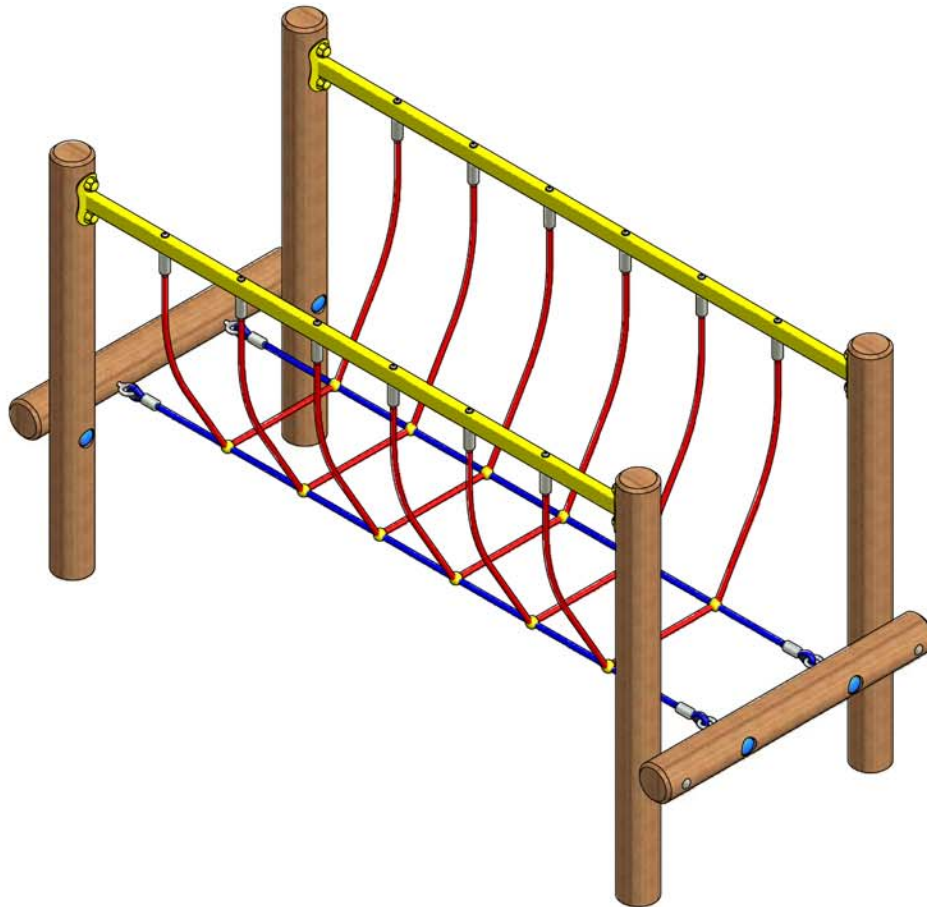

DIMENSIONS: L:2.48 x W:1.0 x H:1.35

#### TECHNICAL DATA

Minimum Space Required	5.48m x 3.9m
Free Height Of Fall	<0.6m
Topsoil or Turf Surfacing	OK
Safer Surfacing Area	5.48m x 3.9m
Intended Age Range	3+
Supervised Play	Recommended
Equipment Type	Outdoor Low Level
Curriculum	Balance, Agility & Co-ordination
Largest Component	2000mm x 50mm x 30mm
Heaviest Component	12.2 kg
Overall Equipment Weight	108 kg
Special Equipment Required	None
Concrete Qty Required	0.13m3

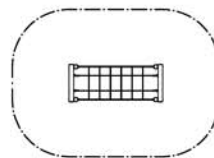

SCALE PLAN 1:200

#### AREA OF SAFER SURFACING

Wetpour	22m2
Durascape	26m2
GrassSaver 22	16 Tiles
Loose Fill	22m2

**API**  
Association of Play  
Industries Registered  
Constructor

**BS EN:1176  
COMPLIANT**

**FAWNS**  
Playtime

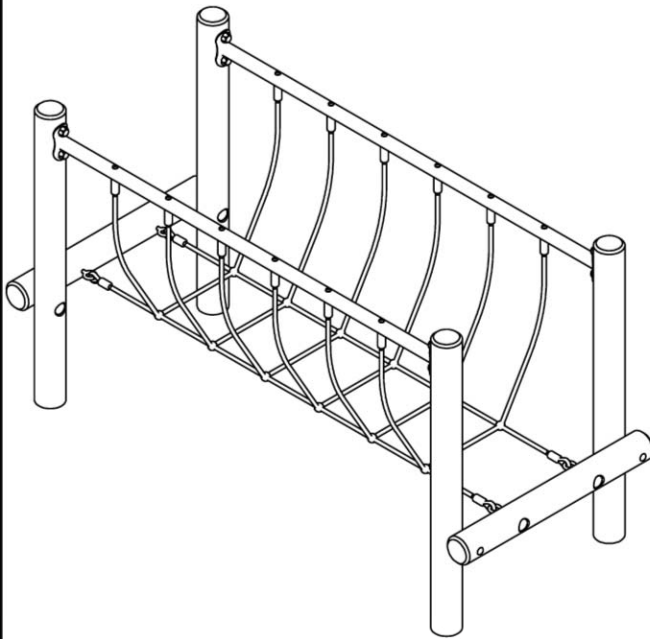

Parts List				
ITEM	QTY	PART No	DESCRIPTION	IMAGE
1	4	FRLT1812_AJ	1800mm x 120/125 dia	
2	2	FRLT1012_AZ	1000mm x 120/125 dia	
3	2	FRMT00442	Bridge Hand Rail	
4	1	FRMS00488	Rope Bridge Rope Set	
5	12	M10X45BHSS	Hexagon Socket Button Head Screw	
6	8	M10X70CS	M10 x 70 Coach Screw	
7	4	M12X230CB	M12 x 230 Coach Bolt	
8	20	M10SWASH	M10 Plain Washer	
9	8	M12WASH	1/2" x 1 1/4" 12G Washer	
10	8	M12NYLOC	M12 Nyloc Nut	
11	8	M10DONUT	M10 Donut	
12	8	PLC480DCAP	Poly Cap 48	

Detail View 1

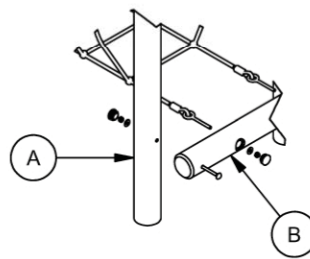

Detail View 2

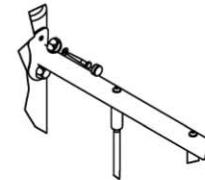

Installation Procedure

1. Excavate foundation holes as shown on sheet 2. When installing into loose surfaces such as sand install the unit 100mm lower into the ground to allow for surfacing loss over time.
2. Assemble the two "H" Frames by connecting posts "A" to crossbeam "B". The assembly should be connected as shown in detail view 1.
3. Position each end assembly into the foundation holes and attach Hand Rails "C" using Coach screws as shown on detail view 2, ensuring to drill a 6mm pilot hole before-hand. Attach Bridge Rope by pushing Eyebolts through the holes in the posts and the inserts up through the steelwork. Check the unit is level and the posts are plumb and square using diagonal measurement as shown on sheet 2.
4. Add concrete around posts, the top of the concrete should be 100mm below the finished surface level and should slope away from posts as shown. See drawing sheet 2.
5. Leave the concrete to set for 48 Hours. If the equipment is likely to be used during this time remove the Bridge Rope from the posts and re attach the following day.
6. Sand and rough edges or surfaces and treat with preservative if necessary.
7. Check and tighten all fixings and install protective caps once checked.
8. This unit must be maintained in accordance with our inspection and maintenance schedule and BS1176 part 7.



Drawing Number: <b>RNB09-IN-AY</b>				
<b>TOLERANCES</b> General ± 1.0 Hole Diameters ± 0.5 Fixing Centres ± 0.5 Angles ± 0.5	Material: <b>See Drg</b>			
	Finish: <b>Clean</b>	New	09/02/09	A
3rd Angle Projection	Drawn By: <b>AK</b>	CN	Date	Issue
Scale: <b>NTS</b>		Sheet: <b>1</b> of: <b>2</b>		
Woodcot Court, 2A Woodcot Gardens, Farnborough, Hampshire GU14 9RD Tel: 01252 515199 Fax: 01252 515858 http://www.fawns.co.uk Email:fawns@fawns.co.uk No part of this document may be copied or used without the express written permission of FAWNS RECREATIONAL SERVICES LTD (c) FRS 2009				

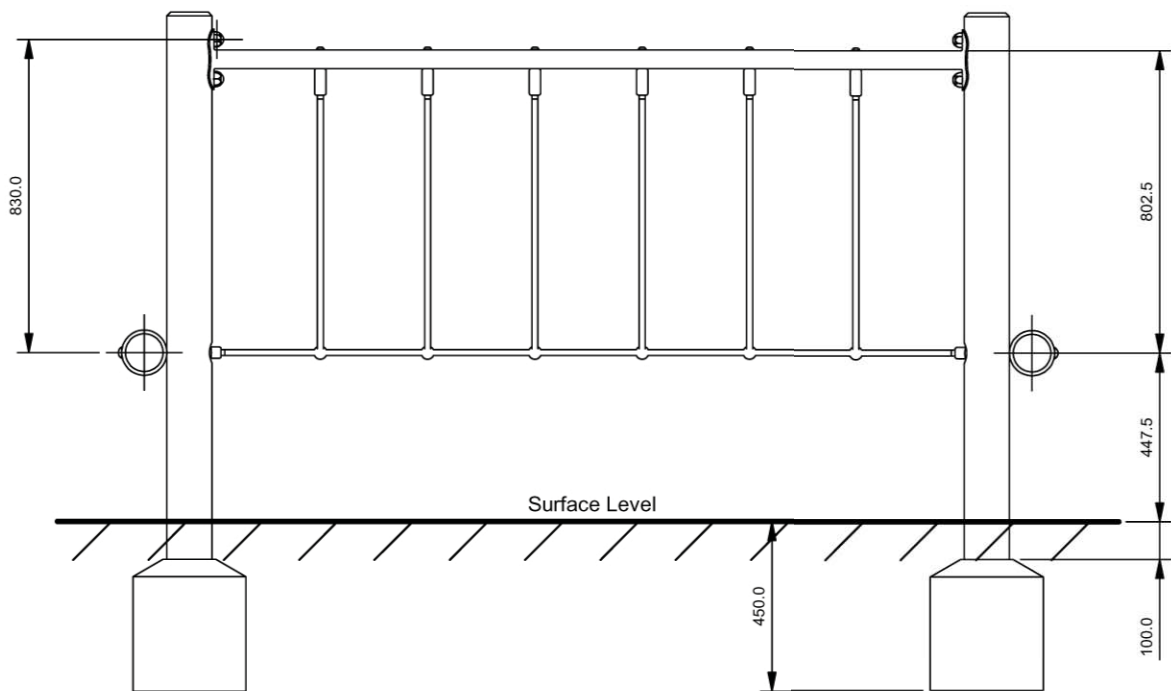
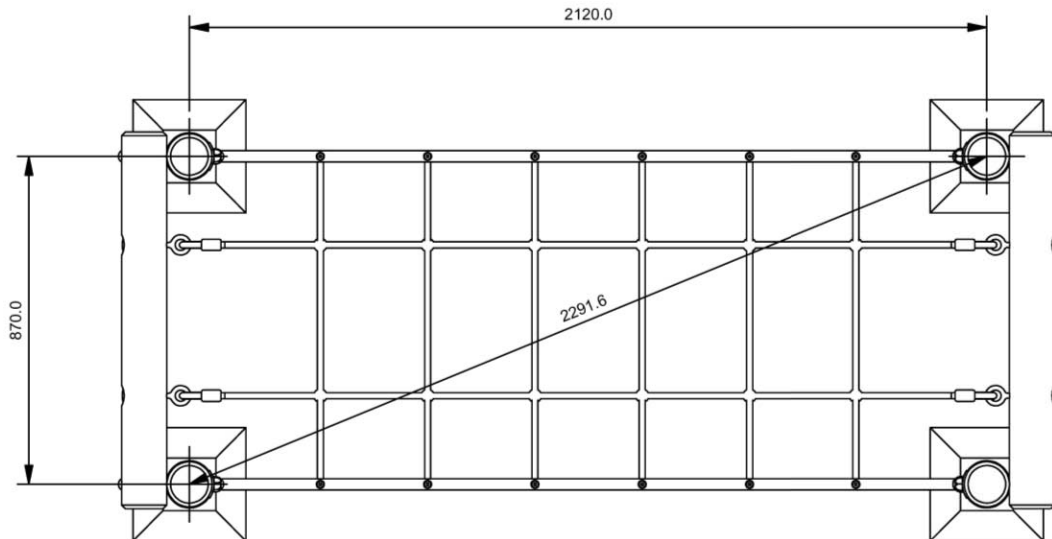

Drawing Number:

RNB09-IN-AY

**TOLERANCES**

General  $\pm 1.0$   
 Hole Diameters  $\pm 0.5$   
 Fixing Centres  $\pm 0.5$   
 Angles  $\pm 0.5$

Material:

See Drg

Finish:

Clean

New	09/09/09	A
CN	Date	Issue

3rd Angle Projection



Drawn By:

AK

Scale:

NTS

Sheet:

2

of:

2