

WE NOT ONLY RECOMMEND THAT CHILDREN ARE SUPERVISED AT ALL TIMES BUT ALSO ADVISE THAT SAFER SURFACING BE USED FOR ALL OUR EQUIPMENT

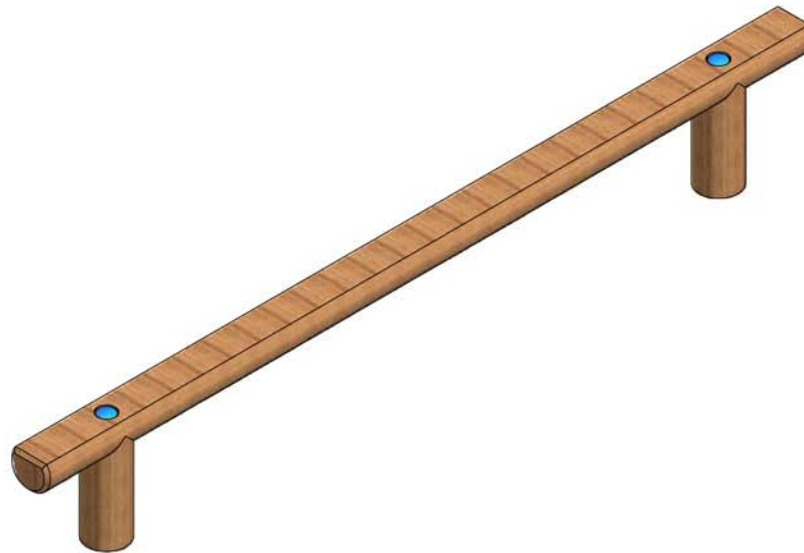

DIMENSIONS: L:2.4 x W:0.12 x H:0.35

TECHNICAL DATA

Minimum Space Required	5.4m x 3.12m
Free Height Of Fall	<0.6m
Topsoil or Turf Surfacing	OK
Safer Surfacing Area	5.4m x 3.12m
Intended Age Range	3+
Supervised Play	Recommended
Equipment Type	Outdoor Low Level
Curriculum	Balance, Agility & Co-ordination
Largest Component	2400mm x 120mm dia
Heaviest Component	16.3 kg
Overall Equipment Weight	26.5 kg
Special Equipment Required	None
Concrete Qty Required	0.1m3

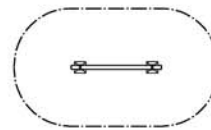

SCALE PLAN 1:200

AREA OF SAFER SURFACING

Wetpour	17m2
Durascape	22.4m2
GrassSaver 22	16 Tiles
Loose Fill	17m2

API
Association of Play
Industries Registered
Constructor

**BS EN:1176
COMPLIANT**



Parts List				
ITEM	QTY	PART No	DESCRIPTION	IMAGE
1	1	FRLT2412_BA	2400mm x 120/125 dia	
2	2	FRLT0712_BB	750mm x 120/125 dia	
3	2	M12X180CHS	M12 x 180 CHS	
4	2	M12SSWASH	M12 Plain Washer Form A SS	
5	2	PLC480DCAP	Poly Cap 48	

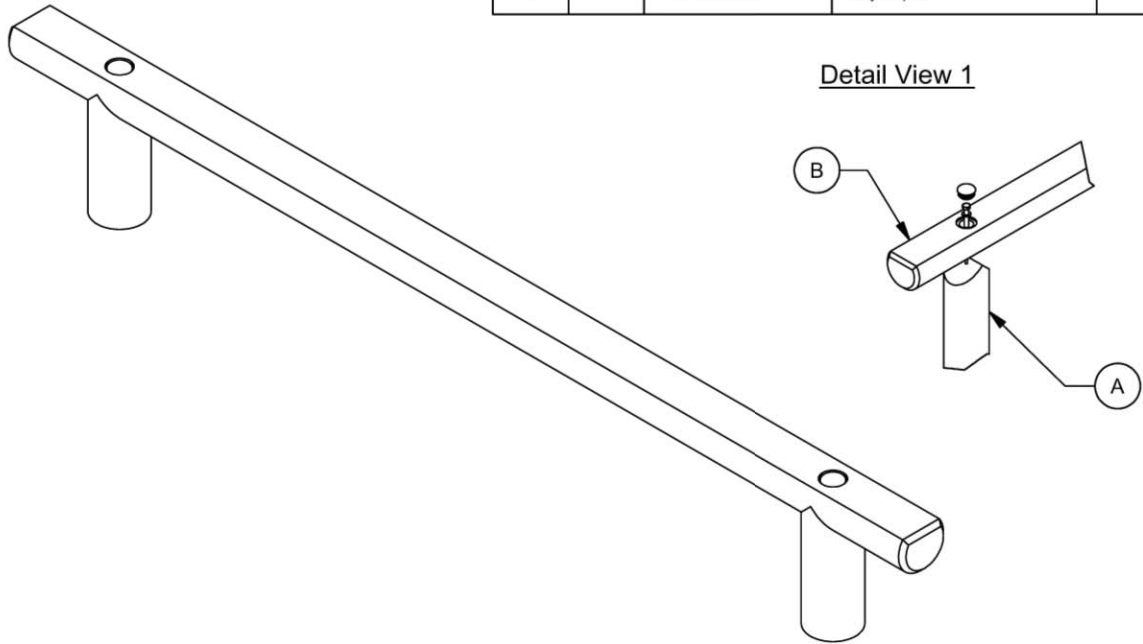



Installation Procedure

1. Excavate foundation holes as shown on sheet 2. When installing into loose surfaces such as sand, install the unit 100mm lower into the ground to allow for surfacing loss over time.
2. Take the two scalloped posts item "A" and drill 8mm pilot holes in the centre of the scallop and attach the top beam item "B" to the scalloped posts as shown in detail view 1.
3. Position the assembly into the foundation holes, check the unit is level and the posts are plumb. Add concrete around posts. The top of the concrete should be 100mm below the finished surface level, see sheet 2.
4. Leave the concrete to set for 48 hours.
5. If stepping, butting, or overlapping any other equipment ensure there is a gap of less than 8mm or greater than 30mm. It may be necessary to cut the beams to achieve this. (Re-treat cuts with appropriate non CCA preservative)
6. Sand and rough edges or surfaces and treat with preservative if necessary.
7. Check and tighten all fixings and install protective caps once checked.
8. This unit must be maintained in accordance with our inspection and maintenance schedule and BS1176 part 7.

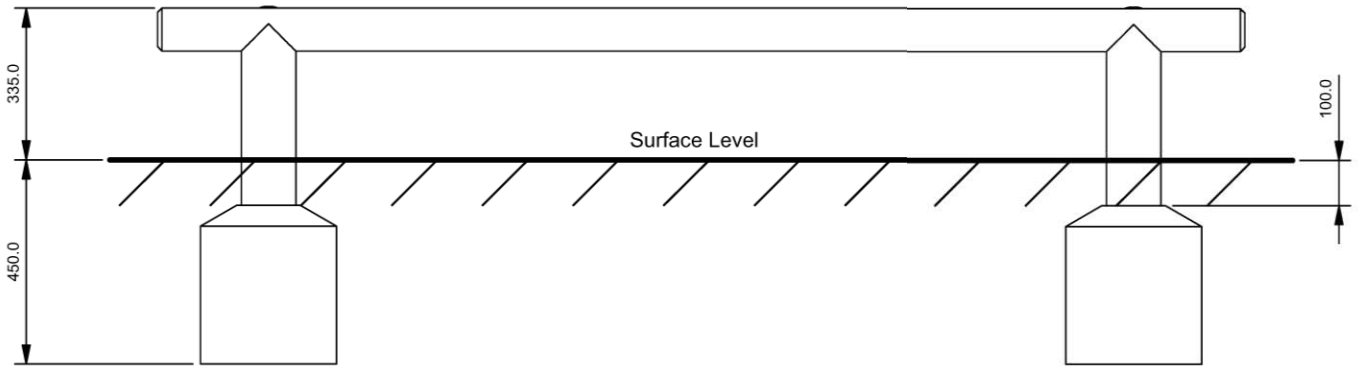
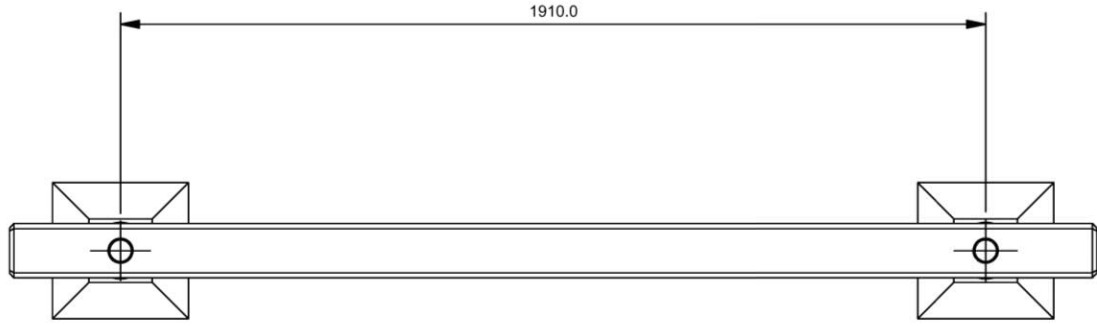

Drawing Number: BBM325-IN-AY				
TOLERANCES General ± 1.0 Hole Diameters ± 0.5 Fixing Centres ± 0.5 Angles ± 0.5	Material: See Drg			
	Finish: Clean	New	09/02/09	A
3rd Angle Projection 	Drawn By: AK	Scale: NTS	Sheet: 1	of: 2
Woodcot Court, 2A Woodcot Gardens, Farnborough, Hampshire GU14 9RD Tel: 01252 515199 Fax: 01252 515858 http://www.fawns.co.uk Email:fawns@fawns.co.uk No part of this document may be copied or used without the express written permission of FAWNS RECREATIONAL SERVICES LTD (c) FRS 2009				



Drawing Number: BBM325-IN-AY				
TOLERANCES General ± 1.0 Hole Diameters ± 0.5 Fixing Centres ± 0.5 Angles ± 0.5	Material: See Drg			
	Finish: Clean	New	09/09/09	A
3rd Angle Projection 	Drawn By: AK	CN	Date	Issue
Scale: NTS		Sheet: 2	of: 2	
Woodcot Court, 2A Woodcot Gardens, Farnborough, Hampshire GU14 9RD Tel: 01252 515199 Fax: 01252 515858 http://www.fawns.co.uk Email: fawns@fawns.co.uk No part of this document may be copied or used without the express written permission of FAWNS RECREATIONAL SERVICES LTD (c) FRS 2009				